





## QUICK START GUIDE







### PACKAGING

- ① 1 x 220V/7.5VDC 1 A mains adapter.
- ② 1 x Z3 display.
- ③ 1 x hinged support.
- ④ 1 x column.
- ⑤ 1 x column support.
- ⑥ 1 x platform.
- ⊕ Accompanying documentation.

## BUTTON FUNCTIONS

	PRESS ONCE	PRESS TWICE	PRESS AND HOLD
	<p>"Clear": Clears the tare, cancels "hold" mode and resets the total accumulated weight.</p>		<p>Switches the display on/off.</p>
	<p>Tare: This may be "normal tare" or "preset tare" depending on the operating mode selected.</p> <p>If the reading is less than five divisions, the display will automatically be set to zero instead of a tare.</p> <p>If there is a preset tare in the memory and there is nothing on the platform, pressing this button deactivates the tare.</p>	<p>This switches the tare mode from "preset tare" to "normal tare".</p> <p>The default operating mode is "preset tare".</p>	
	<p>When the tare function is activated, this switches the display from net weight to gross weight every time the button is pressed. When net weight mode is switched on, "NET" will appear on the LCD display.</p>	<p>HOLD mode activated/deactivated.</p>	<p>Access to the options and default settings menu.</p>
	<p>Prints the weight indicated on the LCD display.</p>	<p>Prints the weight indicated on the display and adds it to the total.</p>	<p>Prints the total accumulated weight and resets the reading to zero.</p>

## DISPLAY COMPONENTS

	<p>Shows the weight of the object(s) on the platform of the weighing device.</p> <p>In HOLD mode, the reading flashes to indicate the last stable weight recorded and not the actual weight on the platform.</p>
	<p>Measurement unit used to indicate the weight.</p>
	<p>Stable weight reading. This indicates that the weight on the platform is not fluctuating.</p> <p>It flashes to indicate that there is movement on the platform.</p>
	<p>Indicates net weight.</p> <p>The net weight is the actual weight on the platform, minus the tare.</p> <p>It is only displayed if a tare has been used.</p>
	<p>Negative sign.</p> <p>This reading may be negative if a tare is activated (in "preset tare" mode) or to indicate a problem when setting it to zero.</p>
	<p>Tare activated.</p> <p>The reading flashes to indicate that "normal tare" mode has been activated.</p> <p>A "preset tare" is retained even after the weight is removed from the platform of the weighing device.</p>
	<p>Battery mode. Not connected to the mains.</p>

# KEYBOARD AND DISPLAY

---

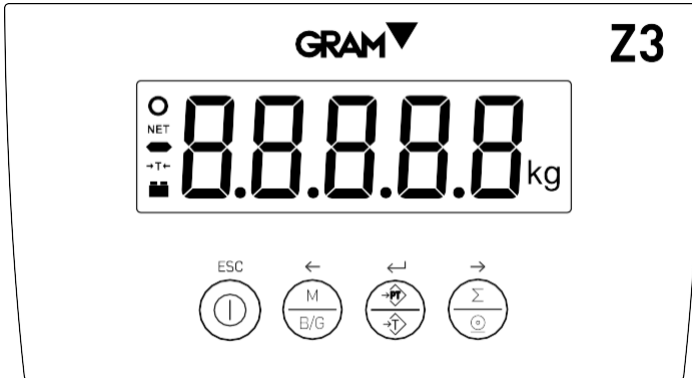

## BASIC FUNCTIONS

---



### Switches the device on/off.

If the button is held down for more than 2 seconds, it acts as an off/on switch.



### Tare a container or object

Place an object or container on the platform and wait until the display indicates a stable reading.

Press the tare key and check that tare is shown on the display; the reading will be "0".

If a "preset tare" (1) is being used, the reading will be negative when the object is removed from the platform.



### Printing a simple ticket

Place an object on the platform and wait until the display indicates a stable reading.

Press the print key to print out a ticket showing the gross and net weights and the tare (2).



### Printing a ticket with an accumulated total

Place an object on the platform and wait until the display indicates a stable reading.

Press the print key twice to print the reading shown on the display and add it to the accumulated weight (2).

Press the print button twice to add and print each of the next weights. At the end of each detail sum, the total accumulated sum appears in the display.

If the print key is held down for more than 2 seconds, the accumulated total is printed and the ticket stops printing. This completes the accumulated total operation and deletes the accumulated total from the memory. The display is ready to start another ticket.



### Hold mode

Press the key twice to activate hold mode.

Once an object has been weighed and removed from the platform, the previous reading flashes on the display.

If another object is placed on the platform, the display will show the new reading in the same way.

To deactivate this function, press the same key twice.

(1) See reference manual to modify this tare function.

(2) Optional printer; not included with the device.

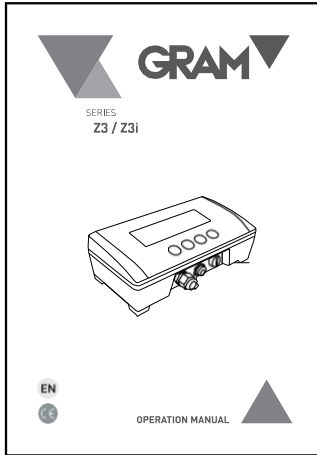

Download the full manual from the following link:

[http://gram-group.com/wp-content/uploads/2016/12/MANUAL\\_Z3\\_2016\\_ENG\\_001.pdf](http://gram-group.com/wp-content/uploads/2016/12/MANUAL_Z3_2016_ENG_001.pdf)

Or by scanning the following QR code:



007/19122016

Gram Precision S.L.  
Travesía Industrial, 11 · 08907 Hospitalet de Llobregat · Barcelona (Spain)  
Tel. +34 93 300 33 32  
Fax +34 93 300 66 98  
comercial@gram.es  
www.gram-group.com

