

## QUICK START GUIDE

### PACKAGING

---

① 1 x Pan.

⊕ Accompanying documentation.

② 1 x S5i bench scale.





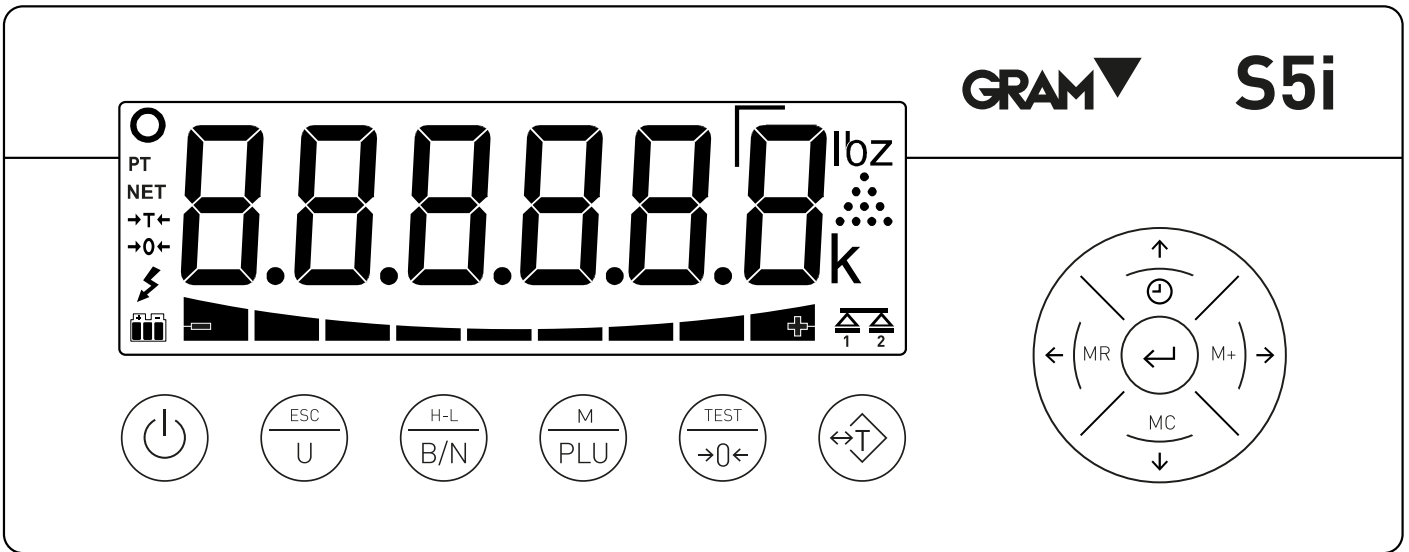



---

## DISPLAY

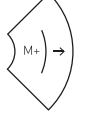
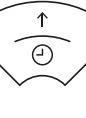
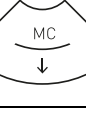

	Shows the weight.
lb/oz	Measurement unit used to indicate the weight.
kg/g	Measurement unit used to indicate the weight.
	Stable weight reading. This indicates that the weight on the platform is not fluctuating.
<b>NET</b>	Indicates net weight. The net weight is the actual weight on the platform, minus the tare. It is only displayed if a tare has been used.
<b>→T←</b>	Tare activated.
	Negative sign. This reading may be negative if a tare is activated or to indicate a problem when setting it to zero.
	Battery mode. Not connected to the mains. Shows the level of the battery charge.
	Connected to the mains.
	Piece-counting mode activated.
<b>→0←</b>	Zero indication.
	Weight range when "control limit" function is on.

## BUTTON FUNCTIONS

	<p><b>Power on/Power off.</b> By pressing this button, the indicator turns on. When the indicator is on, press this button for approximately one second to turn it off.</p>
	<p><b>Weight unit change button.</b> By pressing this button, you can change the weight unit. In menu mode, it will work as an escape button and return to normal mode (Escape). By keeping this button pressed for over one second it starts the piece-counting mode.</p>
	<p><b>Gross/Net button.</b> When the tare is used, pressing this button will show the total weight. Pressing it again will show the net weight. By keeping it pressed for over a second it automatically selects the "Weight limit" mode.</p>
	<p><b>PLU button</b> Press this button to enter the menu and to access previously stored values of weight limits, piece counters, tares and other useful functions. By keeping this button pressed for over a second, it enters the factory mode and asks for a passwords (only accessible to authorised users).</p>
	<p><b>Zero button.</b> It sets the scale to zero, correcting possible deviations. By pressing this button for over a second, it shows the display test, capacity, division and software version.</p>
	<p><b>Tare button.</b> Pressing this button once will subtract the weight of any container or box located on the platform, until the container or box is removed and the tare button is pressed again. Keeping this button pressed will give you access to the tare memory.</p>
	<p><b>MR and left arrow.</b> By pressing this button on the main screen, it closes and sends the accumulated ticket data. It shows the total accumulated weight. In menu mode, it confirms the selected adjustment value and it returns to the previous menu.</p>
	<p><b>M+ and right arrow.</b> Press this arrow to have the device memorise the value shown on the display. It starts the accumulated ticked (if it was not already started) and sends the ticket data to the printer if it is set up. For a few seconds, it also shows the accumulated total. In menu mode, it shows the next function.</p>
	<p><b>Clock and top arrow.</b> By pressing it, it shows the accumulated value. If you press it for over a second it shows the scheduled date and time. In menu mode, it increases the value (digit) of the display.</p>
	<p><b>MC and bottom arrow.</b> In menu mode, it decreases the value (digit) of the display.</p>
	<p><b>Enter.</b> Pressing this button on the main screen, it sends current weight data to the printer (simple mode). By pressing this button for 5 seconds, it will activate the lock/unlock function of the touchpad. In menu mode, it confirms the selection/modification made.</p>

## CONNECTIONS

RS-232      MAIN POWER  
100-240Vac 50/60Hz

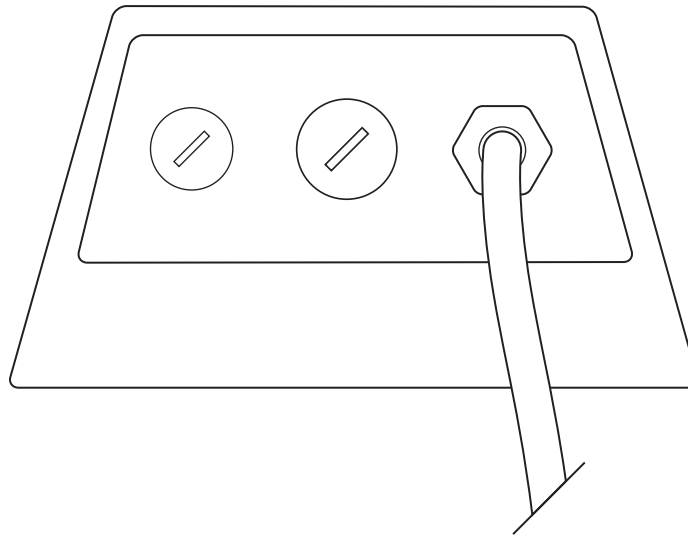

### RS-232 (optional)

DB9 male connector

<b>2</b>	RxD
<b>3</b>	TxD
<b>5</b>	GND

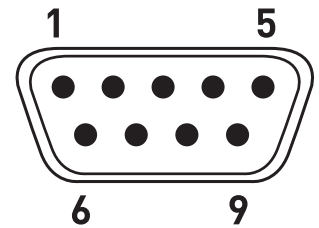

## MORE INFORMATION



Gram Precision S.L.  
Travesía Industrial, 11 · 08907  
Hospitalet de Llobregat · Barcelona (Spain)  
Tel. +34 902 208 000 · +34 93 300 33 32  
Fax +34 93 300 66 98  
comercial@gram.es  
www.gram-group.com

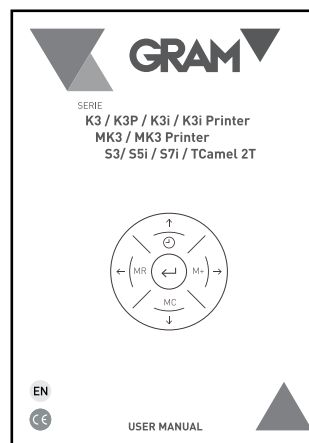

[http://gram-group.com/wp-content/uploads/2016/12/MAN\\_UAL\\_K3\\_2017\\_ENG.pdf](http://gram-group.com/wp-content/uploads/2016/12/MAN_UAL_K3_2017_ENG.pdf)